

Osaki

Instruction Manual

OS-7200H Pinnacle



Before operating this unit, please read these instructions completely.

Thank you for purchasing this Massage Chair.
Before using your massage chair, please read the contents of this
instruction manual and refer to it when needed.

Table of Contents

Safety Precautions	2-3
Chair Components	4-5
Chair installing	6-12
Preparation Before Use	13
Operation Guide	14-25
Grounding Instructions	26
Chair Specification	27
Troubleshooting & Maintenance	28
Warnings	29

01 Safety Precautions

When using the massage chair, basic precautions should always be followed to reduce the risk of electric shock, burns, fire or injury to persons. Please read the following precautions before using the massage chair.

- Make sure the power plug is securely inserted into a proper electrical outlet to reduce the risk of short-circuit and fire.
- It is highly recommended that a surge protector is used to prevent from damage.
- DO NOT use the massage chair in areas where the humidity is high such as a sauna steam room, Pools, bathrooms, AC or heating vents, etc.
- DO NOT use the massage chair outdoors and avoid areas with direct sunlight.
- If the chair is not being used, turn the power switch to the OFF position and unplug the massage chair from the electrical outlet to prevent any damages to the chair when there are power outages/surges that may cause serious damage.
- Never plug/unplug the power cord plug socket with wet hands.
- Close and continuous supervision is necessary when the massage chair is used by, on or near children or disabled persons.
- No more than one person should use the massage chair at the same time.
- The massage chair is intended for use as described in the Instruction Manual. Do not use any attachments other than those recommended by the manufacturer.
- DO NOT attempt to stand or sit on the backrest, armrest or footrest in order to prevent accident, injury or damage to the chair.
- Avoid falling asleep while using the massage chair.
- Always keep the massage chair clean, and never insert any objects into or around the gaps of the massage chair.
- DO NOT move the massage chair by pulling on the power supply cord.
- Make sure there are no children, pets or other obstacles behind or underneath the massage chair.
- If you find any rips or tears in the fabric of the massage chair contact the service department and stop using the chair immediately.

-
- This massage chair is designed for household use and should not be used in non-residential settings.
 - Please consult your doctor if you are in doubt as to whether or not you should use this massage chair.
 - Please consult a doctor before using the massage chair if you are pregnant, undergoing any medical treatment, using a medical electronic device such as a pacemaker, or are experiencing any of the following: Malignant tumor, heart disease, back pain, abnormal or curved back bone, osteoporosis or acute illness.
 - If you experience pain while using the massage chair, stop using the chair immediately and consult your doctor.
 - Never use a massage function on swollen or inflamed parts of the body.
 - DO NOT use the massage chair for more than 30 minutes at a time.
 - DO NOT use the massage chair where aerosol(spray) products are being used or where oxygen is being administered.
 - This massage chair is a non-professional product designed to provide a comfortable massage and should not be substituted for appropriate medical treatment.
 - Never operate the appliance with the air hoses that inflate while they are blocked. Keep the air openings free of lint, hair, and any other obstructions.
 - Check the skin in contact with the heated area of the appliance frequently to reduce the risk of injury. If the heating pad malfunctions and extreme heat is produced it may cause serious burns.
 - Burns may result from improper use. If this is the case immediately shut off the chair and unplug from the outlet.
 - Remove all sharp objects from the body and pockets such as keys and Pens.
 - Keep children away from extended foot support (or other similar parts.)
 - DO NOT WET-DO NOT USE PINS.
 - NEVER REMOVE COVER.

**Caution**

The user's weight is usually limited to 220 lbs.

When using the massage chair, the mechanism will stop for safety while there is too much pressure on it. When that happens, please switch off the power and restart after 10 seconds.

02 Chair Components

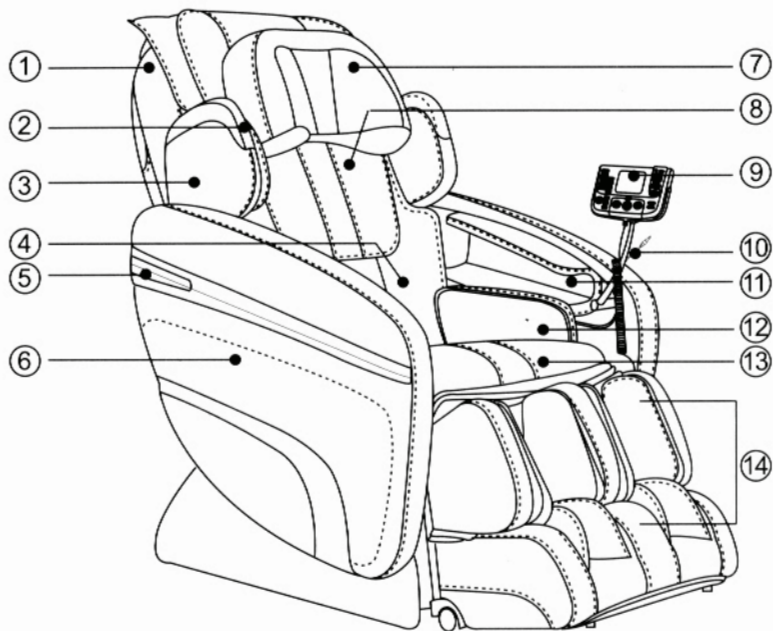

- | | |
|-----------------|------------------------|
| ① Backrest | ⑧ Anti-slip pillow pad |
| ② Music speaker | ⑨ Controller |
| ③ Shoulder | ⑩ Audio cable |
| ④ Backrest pad | ⑪ Armrest |
| ⑤ LED light | ⑫ Seat side |
| ⑥ Side panel | ⑬ Seat cushion |
| ⑦ Pillow | ⑭ Legrest |

Massaging Position

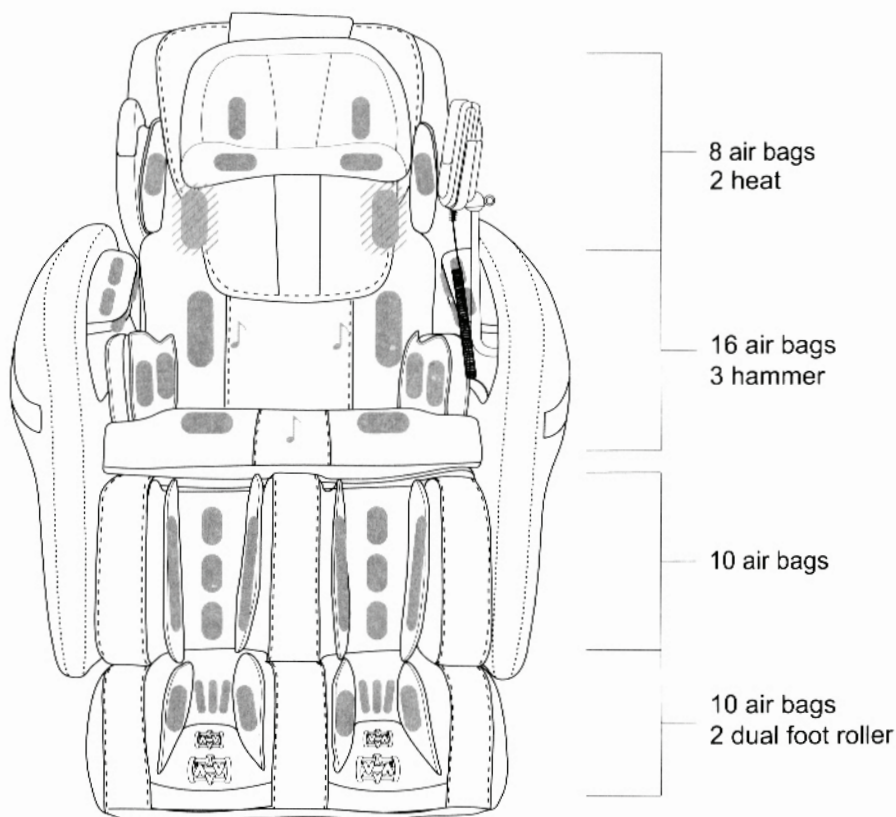

 Music Vibration

 Heat

 Air bag











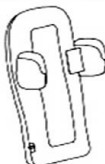



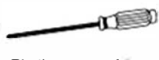

 Foot roller

03 Chair installing



When installing the chair, please leave 31.5" of space behind the back-rest to allow free reclining.
Unplug from outlet when installing parts of the massage chair.

Before installing, please check all the parts in the following list.

1	 Massage chair part	2	 Backrest	3	 Side panel
4	 Backrest pad	5	 Back massage strength-control pad	6	 Pillow pad
7	 Controller holder	8	 Power supply wire	9	 Flat head rivet
10	 Split pin	11	 Phillips screwdriver	12	 φ6*20*2 Nylon spacer
13	 M4*10 Pan head screws*4	14	 φ4*9*1 Gasket*4	15	 M6*55 Hex screws*4
16	 φ6*18*2 Gasket*4	17	 φ6 Spring washer*4	18	 Allen driver

Step 1: Remove the chair parts out of the two cartons:

- 1) Massage chair part
- 3) Side panel

Note: The parts and the serial number of them in the below installation are corresponding to the parts list.

Step 2: Connect pipes and terminals between the side panels and seat part as demonstrated in PIC 1.

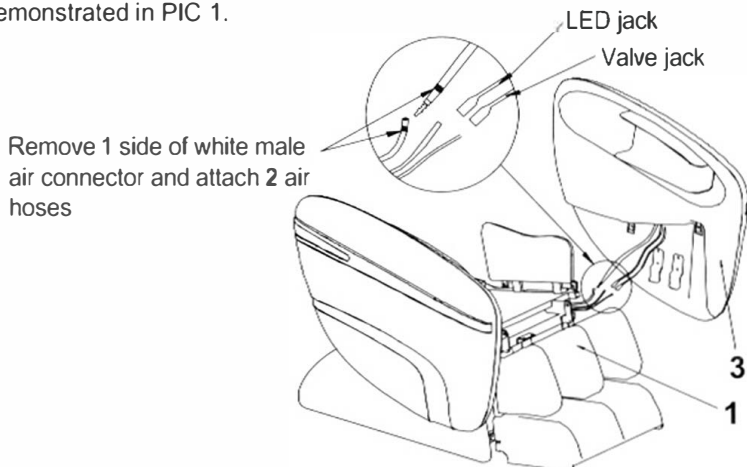

Step 3: Install side panels.

- 1) Insert the side panels along the hook D to the holder C (on the seat) at 90 degrees as demonstrated in PIC 2.
- 2) Adjust the side panel to make the holes aligned, lock the hex screws as demonstrated in PIC 3.

Note: 1) Please be careful to avoid scratching during installation.

2) The hex screws, gaskets and spring washers are packed in a small bag marked "1".

3) Please always bear in mind to fix the side panels to the chair without backrest, meanwhile, lifting up the seat pad for easier to tighten the screws. Once you fix one of the side panels, please don't tighten the two screws immediately until you make sure the two screws are perfectly fitting to each holes.

- 4) Please fix the back screw prior to the front screw while you assemble one of the side panels.

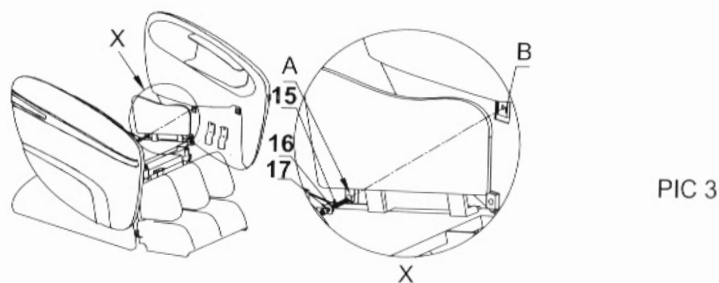
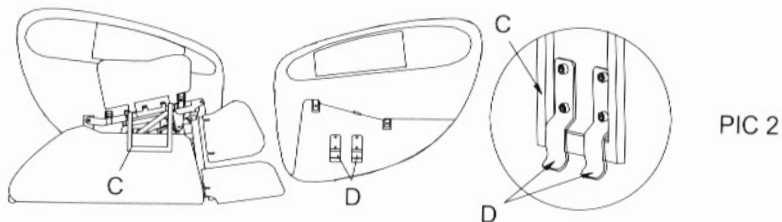

Step 4: Repeat step 2 and step 3 to install the other side panel.

Step 5:

- Use the diagonal pliers to cut off the cable tie which binds the stopper of the backrest and take off the packing material of the backrest actuator, where both of them are located underneath the seat pad.

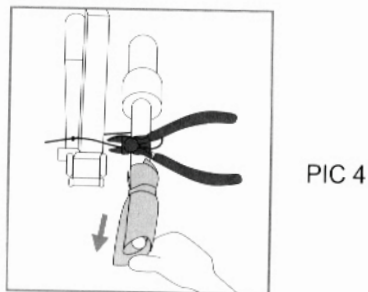

Step 6: Install the backrest.

Lift the backrest, then lower the backrest into the seat brackets. Securely lock the flat head bolts (A) into both sides (B) of the seat as demonstrated in PIC 5.

A. Flat Head Bolt (on the backrest)

B. Holder (on the seat)

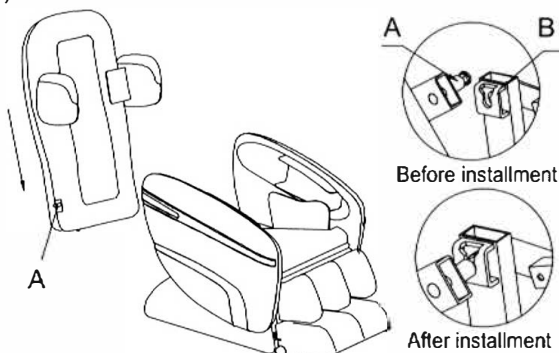

PIC 5

Step 7: Attach the connecting rod (A) and the U stay fork of the reclining actuator (B) with a flat head rivet (C), and secure with a split pin (D), then connect the air pipe and the audio wire in both left and right sides as demonstrated in PIC 6.

A. Connecting rod (on the backrest)

B. U stay fork of reclining actuator (on the seat)

C. Flat head rivet (part 9 in the list)

D. Split pin (part 10 in the list)

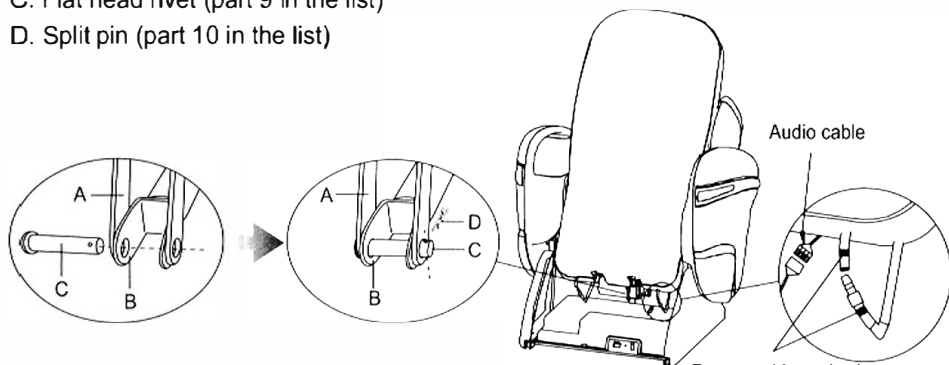

PIC 6

Remove white male air connector on 1 side of chair backrest or frame

Step 8: Insert the wire plugs into the seat as demonstrated in PIC 7.

Note: Insert black to black and grey to grey, otherwise damage to the chair may happen.

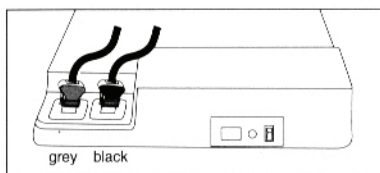

PIC 7

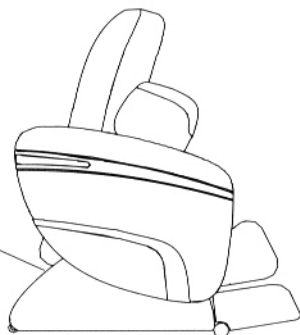

Step 9: Attach the backrest pad and the pillow pad.

- 1) Attach the backrest pad and the pillow pad using the magic tape.
- 2) Attach the backrest pad with the zipper and magic tapes.

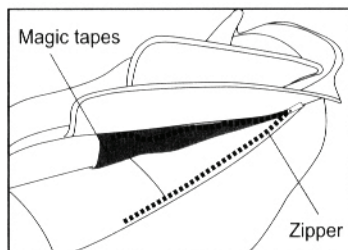

PIC 8

Step 10: Attach the outer coat of the massage pillow that is easy to take off and could be cleaned by water.

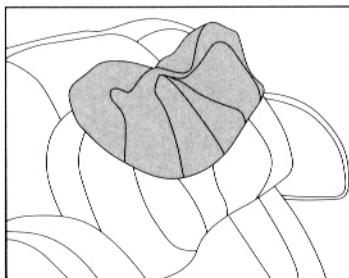

PIC 9

Step 11: Install the controller.

Adjust the positioning holes of controller to match with the ones in the side panel as demonstrated in PIC 11. Lock the screws which are with flat pad when holes C', D', E', F' are corresponding to hole C, D, E, F.

Note: 1. The A and B in PIC 11 are corresponding to PIC 10's A and B.

2. The screws and the gaskets used in this step are packed in a small bag marked "3".

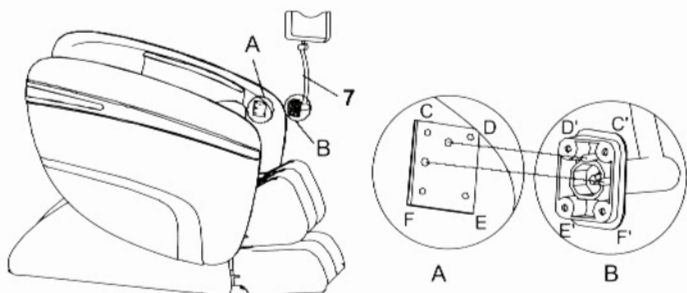

PIC 10

PIC 11

Step 12: Connect the wire plugs.

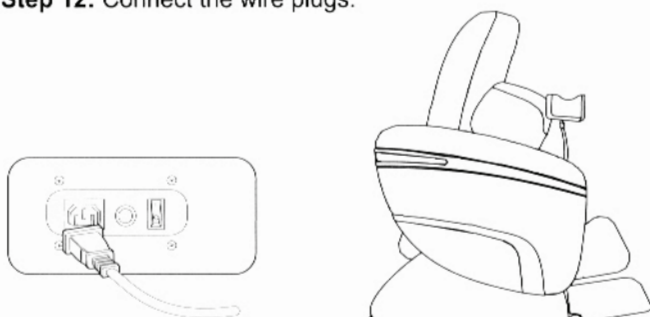

PIC 12

Step 13: Music player can be put inside the remote controller's holder as demonstrated in PIC 13.

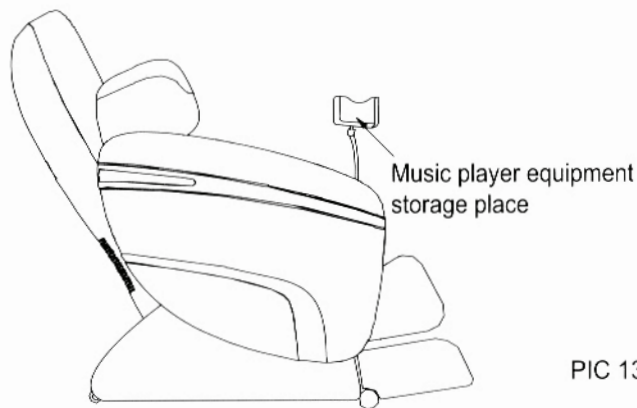

PIC 13

Note: Please use the nylon spacer (put in small bag marked "2") for proper adjustment if the gaps between the side panels and the backrest are different.

04 Preparation Before Use

- To set up the chair
 1. To avoid obstruction to the back and front of the chair, please ensure when the chair reclines, there will be excess space free from any obstacles.
 2. There should be at least 10" for the leg rest and 31.5" for the backrest.
 3. To avoid damage to the floor, it is advisable to place a carpet or cushion under the chair.

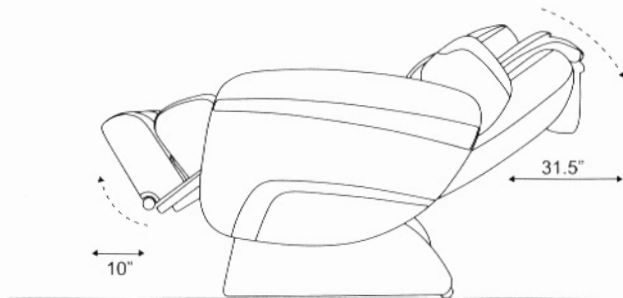

- To move the chair
 1. Lift up the leg rest.
 2. Recline the chair to approximately 45 degrees.
 3. Move the chair around the house with a slight pull and push.

Caution:

- Before moving the chair, adjust the leg rest back into its original position.
- Do not move the massage chair when there is someone seated on it.
- Place a mat underneath the massage chair before moving to protect the floor from scratches.

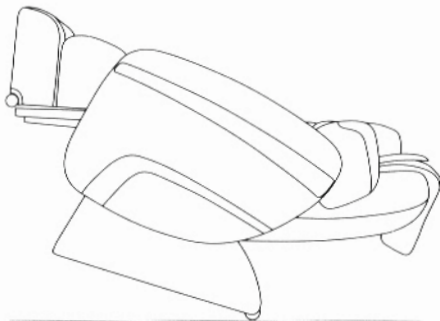

05 Operation Guide

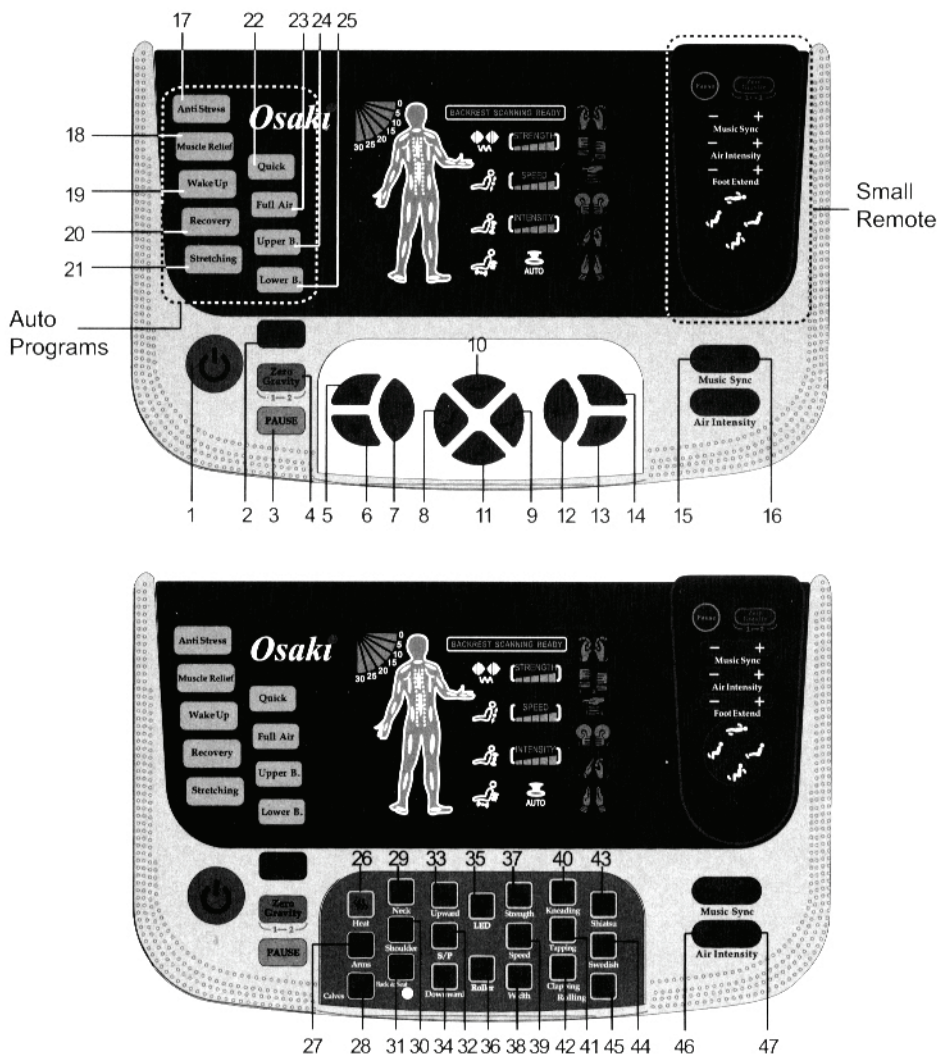

1. Power

- The Power button starts and stops all functions on the massage chair.
- Press once.
- Remote control and side panel LED lights will start blinking to indicate the chair is in idle mode.
- You can press any massage function buttons now to begin your massage session, at a default time of 15 minutes.
- Press again.
- All functions will stop, and massage rollers will return to original position.

2. Timer

- The Timer button controls the length of the massage session.
- The default time for all massage functions is 15 minutes.
- Press each time to change the length of time in the following sequence: 20>25>30>05>10>15 minutes.

3. Pause

- The Pause button will allow all massage functions to stop temporarily.
- Press once and the Pause icon will start blinking on the LED Display.
- Massage functions and timer will be stopped temporarily.
- Press again to resume the massage session.

4. Zero Gravity

- This button activates the Zero Gravity function of the massage chair.
- A Zero Gravity position is a recline position which mimics the posture of astronauts during lift off on space missions. This position is designed to distribute weight effectively across the chair allowing the maximum in stress relief. This also allows for a more intense massage experience. For some users, a Zero Gravity position allows them to feel weightlessness.
- Press once to activate Zero Gravity Position 1. Press again to activate Zero Gravity Position 2.
- Press again to stop.

5/6/7. Backrest Scan

- The Backrest Scan button adjusts the position of the massage rollers to best fit the user's body.
- The product is equipped with an auto-scan function. Press this button to scan your back so that the chair can adjust the position of the massage rollers to best fit your body.
- Alternatively, you can also adjust the height of the massage to fit your personal preference by pressing and holding the Up ▲ / Down ▼ buttons until the rollers reach your preferred position.

8/9. Footrest Lift/Drop

- These buttons allow you to lift or drop the footrest.
- Press once and the footrest will start to lift/drop.
- Press again to stop the footrest at your preferred angle.

10/11. Recline/Incline

- These buttons control the recline/incline angle of the product.
- Press once and the backrest and footrest will move to a horizontal reclining position or an upright sitting position.
- Press again to stop the product at your preferred angle.

12/13/14. Footrest Extension

- These buttons control the footrest extension.
- Press once and the footrest will start to extend/shorten.
- Press again to stop the footrest at your preferred length.

15/16. Music Sync

- This button synchronizes the vibration massage function with the accompanying music rhythm.
- Press "+" once to turn on the synchronization of the vibration massage.
- There are a total of 6 levels of intensity for music synchronization.
- Press "+" to strengthen the vibration massage. You can continue to press until it reaches your preferred intensity.
- Press "-" to weaken the vibration massage. You can continue to press until it reaches your preferred intensity.

Note: Music Sync function can only take place when music is imported into the product. You can import music from MP3, MP4 or your mobile phone to the product with the audio cable provided.

It is recommended that the Music Sync function should not be used for more than 30 minutes.

Please stop for at least 30 minutes after half an hour of use.

To import music, connect the audio cable into the remote control jack. Select your preferred music, and adjust the volume on the music device. You can choose to enjoy the music from the massage chair speakers or by plugging in your own headset into the remote control audio jack.

Remember:

- The music feature of this product only supports music files from MP3, MP4 or mobile phone. It will not be able to read music from other music playback devices such as tablet computers, laptops, or desktops.
- The MP3, MP4 or mobile phone must fit the plug of the audio cable provided.

17. Anti Stress

- This button engages the Full Body Anti Stress Auto Program.
- Press once to start.
- This program focuses on relaxing neck fatigue, using Rolling, Kneading, Tapping, Swedish and Shiatsu modes.
- The default massage session is 15 minutes.

18. Muscle Relief

- This button engages the Full Body Muscle Relief Auto Program.
- Press once to start.
- The program will start with slow Kneading and heavy Tapping massage, progressing to in-depth massage targeting the neck and lower back. This will be especially effective in reducing lower back muscle aches and fatigue.
- The default massage session is 15 minutes.

19. Wake Up

- This button engages the Full Body Wake Up Auto Program.
- Press once to start.
- The program will deliver a light, stimulating Tapping massage throughout the whole body. This will enable your body to feel refreshed and stimulated, ready to start a new day.
- The default massage session is 15 minutes.

20. Recovery

- This button engages the Full Body Recovery Auto Program.
- Press once to start.
- The program combines different massage modes to effectively massage the neck, back and lower back. It is particularly effective as a massage to end a tiring day.
- The default massage session is 15 minutes.

21. Stretching

- This button engages the Full Body Stretching Auto Program.
- Press once to start.
- This program stretches the back muscles, hands, hamstrings and the full body.
- Use this program after a workout to relax sore muscles.
- The default massage session is 15 minutes.

22. Quick

- This button engages the Quick Massage Full Body Auto Program.
- Press once to start.
- This program combines multiple massage modes with air pressure massage to improve the user's vitality.
- The default massage session is 8 minutes.

23. Full Air

- This button engages the Full Body Air Pressure Auto Program.
- Press once to start.
- This program applies full body air pressure massage to the head, neck, shoulder, arm, palm, lower back, buttocks, thighs, calves and feet.
- The default massage session is 15 minutes.

24. Upper B

- This button engages the Upper Body Auto Program.
- Press once to start.
- This program focuses the massage on the upper body, particularly on the shoulders and head with Air, Kneading, Rolling and Tapping massage modes.
- The default massage session is 15 minutes.

25. Lower B

- This button engages the Lower Body Auto Program.
- Press once to start.
- This program focuses the massage on the lower body, particularly on the lower back and calves with Air, Kneading, Rolling and Tapping massage modes.
- The default massage session is 15 minutes.

26. Heat

This button allows you to activate the heat massage model at our shoulders. Press once to start, press again to stop.

27. Arms

- This button allows you to activate the air pressure massage mode at your Arms.
- Press once to start, press again to stop.

28. Calves

- This button allows you to activate the air pressure massage mode at your Calves.
- Press once to start, press again to stop.

29. Neck

This button allows you to activate the air pressure massage mode at your Neck. Press once to start, press again to stop.

30. Shoulder

This button allows you to activate the air pressure massage mode at your Shoulders. Press once to start, press again to stop.

31. Back & Seat

- This button allows you to activate the air pressure massage mode at your Back and Seat.
- Press once to start, press again to stop.

32. S/P (Spot/Partial)

- Press once to localize the massage to a particular point.
- Press again to shift massage to a particular area of body.
- This will keep the original massage node working on a range of 8cm.
- To resume full back massage, press button again.

33/34. Upward/Downward

Position Adjustment Button for Spot or Partial Massage

When the spot or partial massage functions are activated, these buttons move the massage rollers up or down.

Release the button when the desired position is achieved.

35. LED

- This button controls the LED light on the side panel.
- Press once to turn off the LED light.
- Press again to turn on the LED light.

36. Roller

- Press once, to activate the foot roller massage.
- Press again, to stop the foot roller massage.

37. Strength

- This button controls the strength of Kneading massage mode.
- Select a massage function and press to select between 5 levels of massage strength.

38. Width

- This button controls the width of the rollers.
- Select a massage function and press to adjust between Narrow, Normal and Wide widths.
- It can be used to activate the Tapping, Shiatsu and Rolling massage modes.

39. Speed

- This button controls the Speed of Tapping massage mode.
- Select a massage function and press to select between 5 speeds.

40. Kneading

- This button activates the Kneading massage modes. There are 2 Kneading modes.
- Press once to activate the full back massage of Kneading Mode 1; press again for Kneading Mode 2.
- Press again to stop.

Note: Kneading massage mode can be combined with Tapping / Shiatsu / Kneading + Tapping / Kneading + Shiatsu multi massage modes.

41. Tapping

- This button activates the Tapping massage mode.
- Tapping massage can be adjusted to fit 3 widths and 5 speeds.
- Press once to activate the Tapping Mode 1 for a continuous full back massage at medium speed. Press again to enter Tapping Mode 2 for an interval full back massage.
- Press again to stop.

Note: Tapping massage mode can be combined with Kneading.

42. Clapping

- Clapping Function Start/Stop Control Button-3 size of width,5 levels of speed to be adjusted.
- Press this button once to activate the clapping function for a full back massage at medium speed.
- Press this button again to stop the clapping massage function.

43. Shiatsu

- This button activates the Shiatsu massage mode.
- Shiatsu massage can be adjusted to fit 3 widths and 5 speeds.
- Press once to activate Shiatsu Mode 1 for a continuous full back massage. Press again to enter Shiatsu Mode 2 for an interval Shiatsu massage.
- Press again to stop.

44. Swedish

- This button activates the Swedish massage mode.
- Swedish massage can be adjusted to fit 5 speeds.
- Press once to activate Swedish Mode 1 for a continuous full back massage. Press again to enter Swedish Mode 2 for an interval Swedish massage.
- Press again to stop.

45. Rolling

- This button activates the Rolling massage mode.
- Rolling massage can be adjusted to fit 3 widths.
- Press once to activate the Rolling massage mode for a full back massage.
- Press again to stop.

Note: Rolling massage cannot be used to perform "Spot" massage.

46/47. Air Intensity

- This button allows you to adjust the air pressure intensity level for the auto and manual air massage programs.
- Press to select between 5 levels of intensity.

Usage Tips

1. Massage angle

The Anti Gravity button (25) allows you to quickly adjust your massage angle to a Zero Gravity position. There are 2 Zero Gravity positions.

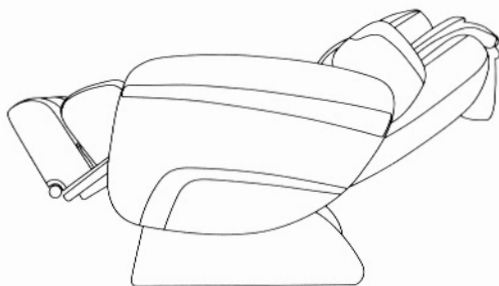

Zero Gravity Position 1 lifts the user off the ground to provide a more comfortable massage angle than common massage chairs.

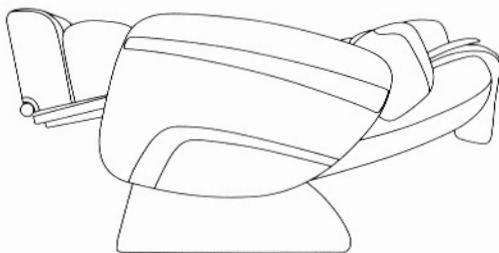

Zero Gravity Position 2 provides a full zero gravity position that raises the lower body even higher. This allows the product to deliver a more intense massage experience.

2. Massage intensity

You can adjust the intensity of Air Pressure massage with the Air Intensity button (42), choosing from a total of 5 intensity levels. You can adjust the Speed of all Tapping massage modes with the Speed button (34), and the Strength of all Kneading massage modes with the Strength button (33).

If you prefer the massage to be stronger still, you can remove the inner cushion from the backrest cover. The backrest inner cushion can be replaced to reduce the massage intensity.

Note: When you receive the chair, the inner cushion has already been placed inside the backrest cover.

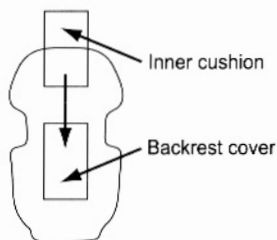

3. Head massage

Massage and anti-slip pillows have been provided with the massage chair to provide a comfortable head massage. In particular, the Full Air button (11) should be enjoyed with both pillows to prevent the pillow(s) slipping out while enjoying the air squeezing massage on your neck.

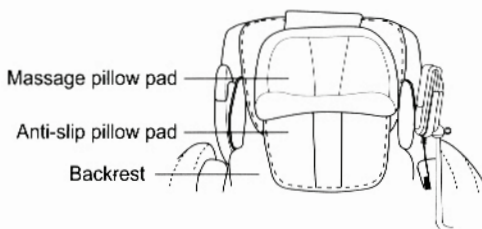

4. Neck massage

Removing the massage pillow pad and leaving just the anti-slip pillow pad will allow your neck to enjoy a more intensive massage. Removing both anti-slip and massage pillow pads will allow the most intensive massage.

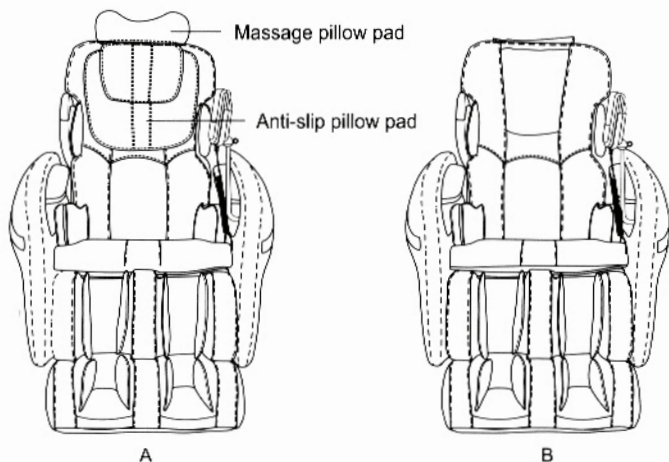

Figure A: By removing the massage pillow pad and leaving just the anti-slip pillow pad, you can experience a stronger neck massage.

Figure B: By removing both the massage and anti-slip pillow pads, you can experience the strongest neck massage.

5. Stretching

When you start the Stretching button (12), be sure that you are in the correct seating position. In particular, tuck your hands into the armrest air bags.



6. Operations

First connect the chair power plug to a power supply, then turn the switch on. The chair is now in idle mode. In this mode, the following 6 functions are the only ones that will operate: ON/OFF (1), Pause (3), Footrest Extension (21/22), Recline/Incline (19/20) and Footrest Lift/Drop (23/24).

06 Grounding Instructions

This product must be grounded. If it should malfunction or break down, grounding provides a path of least resistance for the electric current to reduce the risk of electric shock. This product is equipped with a cord with an equipment-grounding conductor and a grounding plug. The plug must be plugged into an appropriate outlet that is properly installed and grounded in accordance with all local codes and ordinances.

Danger-Improper connection of the equipment-grounding conductor can result in a risk of electric shock. Check with a qualified electrician or service technician if you provided with the product-if it will not fit the outlet, have a proper outlet installed by a qualified electrician.

This product is for use on a nominal 120V circuit and has grounding plug that looks like that plug illustrated below. Make sure that the product is connected to an outlet having the same configuration as the plug. No adapter should be used with this product.

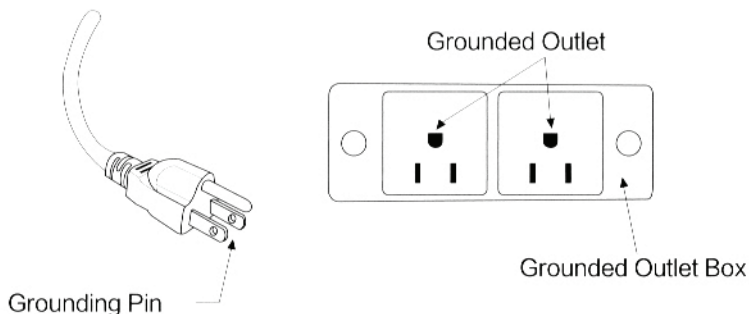

07 Product Specifications

Description	Specifications
Model No.	OS-Pro Pinnacle
Rated Voltage	110-120V~
Rated Frequency	50/60Hz
Rated Power Consumption	250W
Timer	5/10/15/25/30 minutes
Import sound source	MP3, MP4, mobile phone
The power of loudspeaker	2W (one side)
Dimension (L x W x H)	Product carton: 54.3" x 29" x 38.4"
	Side panel carton: 25.8" x 15.7" x 39.4"
Weight	Product gross weight: 266.8 lbs
	Product net weight: 231.5 lbs
Length of the wire	Controller wire: 59"
	Power supply wire: 71"
	Audio wire: 25.6"
Usage condition	Environment temperture: 10°-40°
	Contrasting humidity: 30-85RH
Storage condition	Storage temperture: 20°-60°
	Storage humidity level: 30-85RH
Safety feature	Equipped with overheated and power surge safety protection.
Using benefits	Increasing blood circulation; Relieving muscular fatigue

08 Troubleshooting

This chapter summarizes the most common problems you could encounter with the massage chair. If you are unable to solve the problem with the information below, contact immediately.

If the problem encountered is not listed here, please first try the following steps:

1. Unplug the product for 60 minutes.
2. After 60 minutes, plug in the product again
3. Turn on the Power Switch.

Problem	Possible Cause	Solution
The massage chair does not work.	The appliance is not plugged in.	Put the main plug in the wall socket. Check if the voltage on the appliance corresponds to the local mains voltage.
	The appliance has just finished its 15 minutes massage and has automatically switched to standby mode.	If you want another massage, press the POWER button again.
	You have used the appliance continuously for 45 minutes, causing the overheat protection to switch off the appliance.	Unplug the appliance and let it cool down for 60 minutes before you use it again.
	An excessive weight has been put on the appliance (e.g. someone has stood on the appliance or a heavy object has been put on top of it).	Unplug the appliance, remove the excessive weight if it is still on the appliance again and switch it on.
The appliance is warm.	You have let the appliance run for more than 45 minutes in a row.	Unplug the appliance and let it cool down. Always unplug the appliance after use.
Sound can be heard during massage.	This sound is caused by the mechanical structure of the appliance.	This sound is normal and does not mean that the appliance is malfunctioning.

09 Warnings

- Do not use water and other cleaning detergents on the massage chair.
- Do not stack, stab, slit or harshly pull on the surface of the massage chair.
- Gently press the buttons during operation and avoid hitting the buttons with hard objects.
- Pull out the power supply plug after each use.
- Do not use the massage chair for more than 30 minutes at a time.
- DO NOT position any body part in between the gaps of the leg rest when the automatic leg extension feature is in operation as demonstrated PIC 1, in order to prevent pinch to you. If you are remiss to position any body part in between the gaps of leg rest, please press ON/OFF button to stop and then get your body part out rapidly as demonstrated PIC 2.
- If you have to rise from the chair to stop accident, injury or damage to others by you or you want to get your feet and calves out when the automatic leg extension feature is in operation, please press ON/OFF button to stop as demonstrated PIC 2, the footrest will gradually deflate in some seconds and then quickly get your foot and calves out and rise.

Note: This way as above mentioned just using in emergencies. Please bear in mind that always return the footrest to its original length and restore it to its original position, then rise from the chair in order to prevent accident, injury or damage to yourself and chair.

